



CANSAT KURSUS

efterår 2020

Jens Dalsgaard Nielsen, AAU
Henrik Bay Madsen, NVH
Steen Eiler Jørgensen, Astra

se også

<http://jensd.dk/cansat>



tentativ agenda

- velkommen
- udlevering af kit
 - install af SW
 - arduino IDE
- gennemgang af cansat shield
 - biblioteker for cansat shield
- Afdækning af folks programmeringserfaringer
 - gætter på fra ingenting til meget kompetente
- enkle hello world programmer

- start på kit
- trykmåler (bmp085/bmp180/...)
- accelerometer (MPU6050)
- gyro (MPU6050)
- magnetometer (hmc5983)
- logning på sd card
- radiolink
- apc220
- configuration
- den store test
- pewww



ARDUINO INSTALL

- <http://arduino.cc>
- <https://www.arduino.cc/en/software>

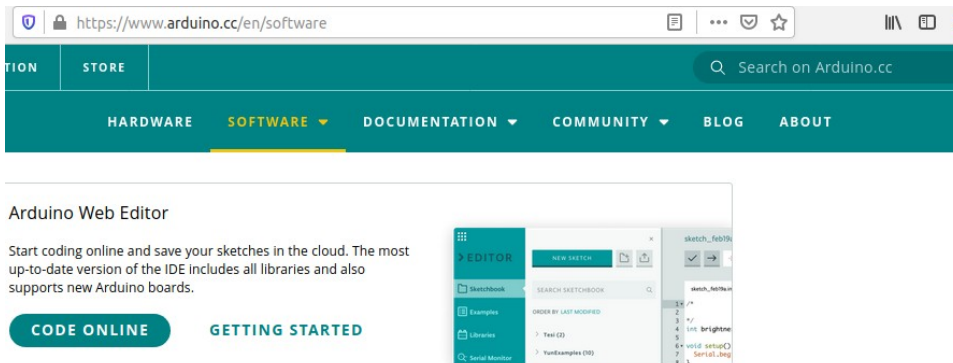

Downloads



Arduino IDE 1.8.13

The open-source Arduino Software (IDE) makes it easy to write code and upload it to the board. This software can be used with any Arduino board.

Refer to the [Getting Started](#) page for Installation instructions.

SOURCE CODE

Active development of the Arduino software is [hosted by GitHub](#). See the instructions for [building the code](#). Latest release source code archives are available [here](#). The archives are PGP-signed so they can be verified using [this](#) gpg key.

DOWNLOAD OPTIONS

Windows Win 7 and newer

Windows ZIP file

Windows app Win 8.1 or 10

Linux 32 bits

Linux 64 bits

Linux ARM 32 bits

Linux ARM 64 bits

Mac OS X 10.10 or newer

[Release Notes](#)

[Checksums \(sha512\)](#)

DOWNLOAD OPTIONS

Windows Win 7 and newer

Windows ZIP file

Windows app Win 8.1 or 10



Linux 32 bits

Linux 64 bits

Linux ARM 32 bits

Linux ARM 64 bits

Mac OS X 10.10 or newer

[Release Notes](#)

[Checksums \(sha512\)](#)



C - a programming language

- Small language
- Used everywhere
 - from micro-controllers running slower than 1MHz in clock
 - to super computers running more than 3 GHz
 - A span of more than 3000 times (not counting CPUs)
 - from less than 1 kByte memory in systems
 - to much more than TBytes
- Language for coding linux operating system
- Language for coding MAC OS
- Windows ??
- You name it

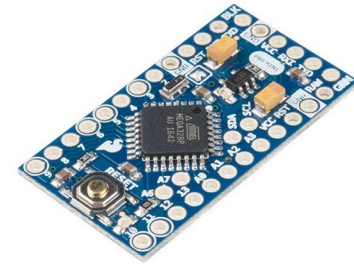



nogle links

- <https://www.arduino.cc/en/Tutorial/HomePage>
- <https://microcontrollerslab.com/arduino-programming-tutorial-beginners/>
- <http://jensd.dk/cansat/c-course>
- <http://jensd.dk/cansat>



Programming in an imperative language

- Imperative language
- Execution of statement programmed by you
- One at a time
- In the order given by you - Order is important - change in order might change result.
- Programs are structured in blocks or functions
- Blocks of functions can execute other blocks



Programming in an imperative language

- Imperative language
- Execution of statement programmed by you
- One at a time
- In the order given by you - Order is important - change in order might change result.
- Programs are structured in blocks or functions
- Blocks of functions can execute other blocks



Seq ordered execution

- 1) start code (invisible)
- 2) execute **setup** statement by statement
- 3) back to invisible part
- 4) execute loop statement by statement
- 5) goto 4) and execute again
- 6) until infinity ...

A statement is either

- execution of a block/function
 - and return back to where it was called
- execution of a statement

```
File Edit Sketch Tools Help
[Icons]
sketch_aug26b §
1
2
3
4 void setup() {
5
6 }
7
8 void loop() {
9
10
11 }
```



Functions

Order of execution

- 1) setup
- 2) loop
 - 1) aBlock
 - 1) nextLevelBlock
 - 2) anotherBlock
- 3) back to 2)

```
setup
loop
  aBlock
  nextLevelBlock
  anotherBlock
loop (again)
  aBlock
  nextLevelBlock
  anotherBlock
loop (again)
  aBlock
  nextLevelBlock
loop (again)
  aBlock
  nextLevelBlock
  anotherBlock
...
```

```
File Edit Sketch Tools Help
sketch_aug26b $
1
2 void nextLevelBlock() // head or interface
3 {
4   // code missing
5 }
6
7 void aBlock() // head or interface
8 {
9   // body - the functionality
10  // ...
11  nextLevelBlock();
12  // ...
13 }
14 void anotherBlock() // head or interface
15 {
16   // here will come som code
17 }
18
19
20 void setup() {
21   // missing code
22 }
23
24 void loop() {
25   aBlock(); // calling or execute aBlock
26   anotherBlock();
27 }
```



Functions “1”

Consists

- a head : your interface to the function
- a body: which holds the code the function execute

head - syntax:

```
void NAME ()
```

- name might be a, bec vrst
- case sensitive Jens, jens, jeNS, jENS are different names
- you can't use national letters like jørgen (ø :-)

examples

```
void setup() :-)  
void myFirstfunction()
```

body - syntax:

```
{  
  // statement or calling another function  
}
```



Functions “2”

```
void x()  
{  
    // do something  
}
```

execution of function x

```
...  
x();           // name + () + ;           “;” is end of a statement (like “.” in danish)
```



the C/function flow

- /&%x/%&/x#"&x%%(/&%
- loop calls aBlock
 - aBlock calls nextLevelBlock
 - nextLevelBlock executes and return to ...
 - aBlock which returns to ...
- loop
- loop calls anotherBlock
 - anotherBlocks executes and return to ...
- loop
- loop return (after last statement)
- loop "loops" to start of loop and
- loop calls aBlock (first bullet)
- ... etc

Line numbers

24

25->7 (call aBlock)

8,9,10->2

2,3,4,5 return to 10+

11 return to 25+

26->13 (call anotherBlock)

14,15,16 return to 26+

27 loop to 24

```
File Edit Sketch Tools Help
[Icons: Checkmark, Arrow, Grid, Up Arrow, Down Arrow]
sketch_aug26b §
1
2 void nextLevelBlock() // head or interface
3 {
4 // code missing
5 }
6
7 void aBlock() // head or interface
8 {
9 // body - the functionality
9 // ...
10 nextLevelBlock();
11 } // ...
12
13 void anotherBlock() // head or interface
14 {
15 // here will come som code
16 }
17
18
19
20 void setup() {
21 // missing code
22 }
23
24 void loop() {
25 aBlock(); // calling or execute aBlock
26 anotherBlock();
27 }
```



Need some debugging - need to see what is going on

File Edit Sketch Tools Help

ets Jun 8 2016 00:22:57

```
1 void setup() {
2   Serial.begin(115200);
3   delay(1000); // relax
4 }
5
6 void aaa()
7 {
8   Serial.println("aaa");
9   delay(1000); // wait one second here
10  return;
11 }
12
13 void aa()
14 {
15   Serial.println("aa");
16   delay(1000); // wait one second here
17   aaa();
18   return;
19 }
20
21 void a()
22 {
23   Serial.println("a");
24   delay(1000); // wait one second here
25   aa();
26   return;
27 }
28
29 void loop() {
30   Serial.println("loop");
31   a(); // calls function a
32   delay(5000); // calls delay which delay execution by 5000 milliseconds
33 }
```

rst:0x1 (POWERON_RESET),boot
configsip: 0, SPIWP:0xee
clk_drv:0x00,q_drv:0x00,d_drv:
mode:DI0, clock div:1
load:0x3fff0018,len:4
load:0x3fff001c,len:1044
load:0x40078000,len:8896
load:0x40080400,len:5816
entry 0x400806ac
loop
a
aa
aaa
loop
a
aa
aaa
loop
a
aa
aaa
loop
a
aa
aaa
loop
a
aa
aaa
loop
a
aa
aaa



Serial.println - a function

- prints :-)
- only one item: text or numbers.
- numbers
 - 1 2 456 -34 integers (heltal)
 - 1.23 -1.23e7 floating point (kommatal)
- text
 - "letters in between"
- `Serial.println("ost");` //prints ost and force a linebreak after
- `Serial.println(123);` // prints 123 and force a ...
- Need to initialize port with writing speed
- `Serial.begin(115200);` // for ce nerds 115200 bit pr second



```
aaaa  
1 void setup() {  
2   Serial.begin(115200);  
3   delay(1000); // relax  
4 }  
5  
6 void aaa()  
7 {  
8   Serial.println("aaa");  
9   delay(1000); // wait one second here  
10  return;  
11 }  
12
```



serial interface

- 115200 bits pr second
- delay pause execution
- "return" returns from a funcnior

```
aaaa ████████████████████████████████████████████████████████████████████████████
1 void setup() {
2   Serial.begin(115200);
3   delay(1000); // relax
4 }
5
6 void aaa()
7 {
8   Serial.println("aaa");
9   delay(1000); // wait one second here
10  return;
11 }
12
```



serial terminal (in menu "tools")

The screenshot shows the Arduino IDE interface. The main window displays a sketch with the following code:

```
1 void setup() {
2   Serial.begin(115200);
3   delay(1000); // relax
4 }
5
6 void aaa()
7 {
8   Serial.println("aaa");
9   delay(1000); // wait one
10  return;
11 }
12
13 void aa()
14 {
15   Serial.println("aa");
16   delay(1000); // wait one
17   aaa();
18   return;
19 }
20
21 void a()
22 {
23   Serial.println("a");
```

Overlaid on the sketch is a serial terminal window titled "/dev/ttyUSB0". The terminal has a "Send" button at the top right. At the bottom, there are controls for "Autoscroll" (checked), "Show timestamp" (unchecked), a dropdown menu set to "Both NL & CR", a dropdown menu set to "115200 baud", and a "Clear output" button. Two arrows point from the text "serial terminal (in menu 'tools')" to the serial terminal window and the "Tools" menu icon in the IDE's top bar.



TEST -1

- Arduino UNO
- testprogram
- File -> examples -> digital -> BlinkWithoutDelay
- Tools-> Board -> Uno
- Tools -> Port -> den USB port din Arduino sidder på
- ctrl-u (compiler og upload)
- blinker LED
- JA: mission completed



første rigtige program

-
-
- Lav ADC eksempel
- print måling med 5 msec delay imellem
- sæt en ledning til adc indgang og hold ved den
- print og plot og se resultat

- BRUG FUNKTIONER !!!
- med parametre (Jens viser eksempel online)



```
imp03-ex01
1 void setup() {
2     Serial.begin(115200);
3     delay(1000);
4 }
5
6 int maaling;
7 float voltage;
8
9 float omregn(int val, int valMax, float vMax)
10 {
11     return ( val * vMax / valMax );
12 }
13
14 void loop() {
15     maaling = analogRead(36); // nodeMCU adc0
16     voltage = omregn(maaling, 4095, 3.3);
17     Serial.println(voltage, 3);
18     delay(20);
19 }
20
21 /* TRICKS
22 For at undgaa debug beskedderne når man rebooter
23 kan man sætte GPIO15 til stel(gnd).
24 Hvis du vil serial plotte ovenstående så
25
26 1. hold RESET knappen nede
27 2. start upload
28 3. slip RESET knappen lidt efter
29
30 efter upload
31
32 1. hold EN knappen nede
33 2. start seriel plotter
34 3. slip EN knappen
35
36 JDN
37 */
```



```
1 void setup() {
2     Serial.begin(115200);
3     delay(1000);
4 }
5
6 int maaling;
7 float voltage;
8
9 float omregn(int val, int valMax, float vMax)
10 {
11     return ( val * vMax / valMax );
12 }
13
14 void loop() {
15     maaling = analogRead(36); // nodeMCU adc0
16     voltage = omregn(maaling, 4095, 3.3);
17     Serial.println(voltage, 3);
18     delay(20);
19 }
```



exercise 2

- *Lav ADC eksempel*
- *print måling med 5 msec delay imellem*
- *sæt en ledning til adc indgang og hold ved den*
- *print og plot og se resultat*
-
- *Lav midlingsrutine så du måler 5 gange med 1 millisek imellem og midler*
- *print*
 - *alle 5 værdier*
 - *og midlede værdi 5 gange*

 - *hint `Serial.print(arr[i]); Serial.print(" "); Serial.println(average);`*
 - *så kan du plotte dem*
- *ledning i adc indgang og hold ved ledning*



analog Input rå

- har i ledning på pin 36 og holder ved enden af ledningen
- jeg opfanger 50 Hz støj fra verden (får port i mætning da maks jo er 1023)
- ACD får i mætning
- fra 236431 til 236531 er der 100 målinger dvs 100 millisekunder ca (se kode)
- der er 5 perioder som varer $5 \cdot 20 \text{ msek} = 100 \text{ msek}$ (50Hz ~ 20 msek pr periode) :-) (NB figur er fra en micro med 12 bit opløsning dvs 4095 niveauer)

```
1 void setup() {
2   Serial.begin(115200);
3 }
4 // menu tools(værktøjer på dansk) ->
5 // ctrl+shif+l
6
7 void loop() {
8   delay(1);
9   Serial.println(analogRead(36) );
10 }
11
```

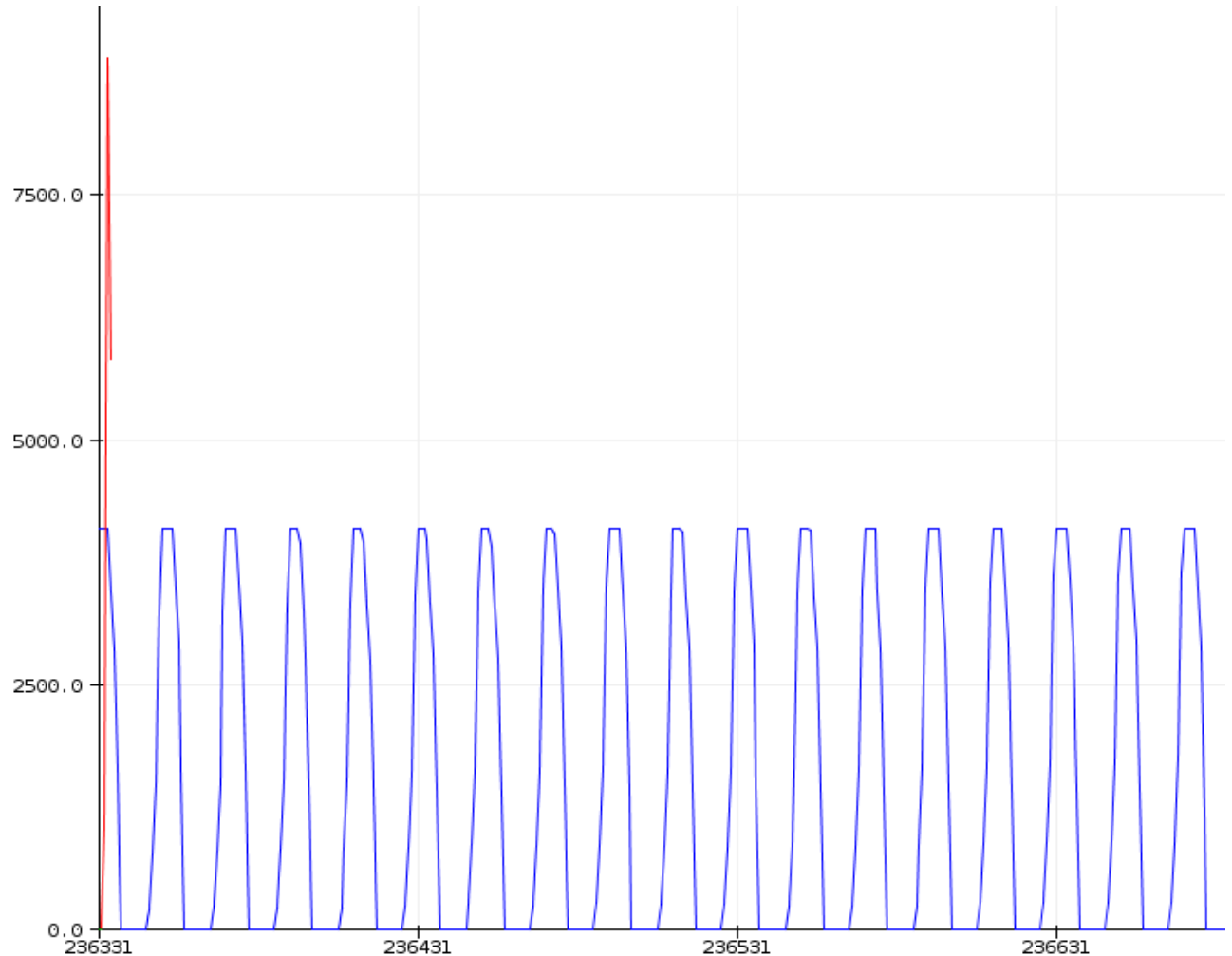

Done uploading.

```
Invalid library found in /home/jdn/q/code
Invalid library found in /home/jdn/q/code
```



- ESP32 digital pin HIGH = 3.3V
- LED Voltage drop ~ 2.2V
- 1.1 V left for the diode
- <https://ardustore.dk/produkt/led-diode-3m>
- from the sheet
 - continuous forward current max 30 mA
- $R = (3.3 - 2.2) / 0.03A = 36 \text{ ohm}$
- $i = 10 \text{ mA} \rightarrow R = (3.3 - 2.2) / 0.01A = 110 \text{ ohm}$
- higher current == more light
- pin -> LED -> resistor or
- pin -> resistor -> LED - no difference

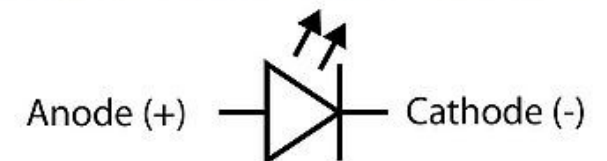
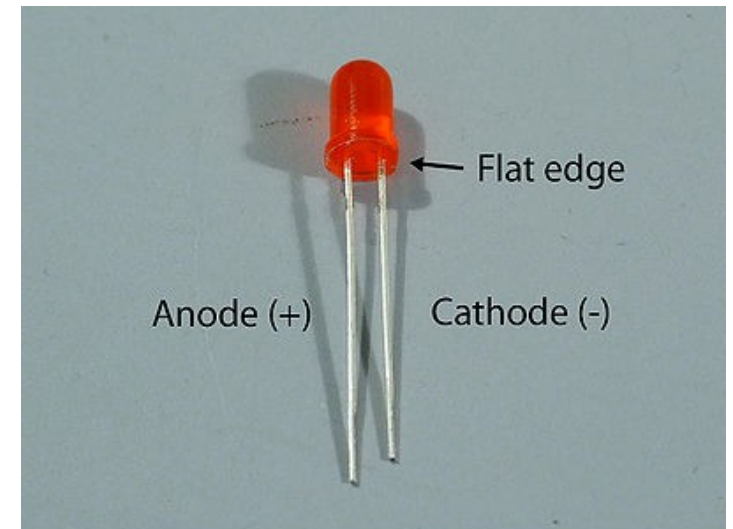
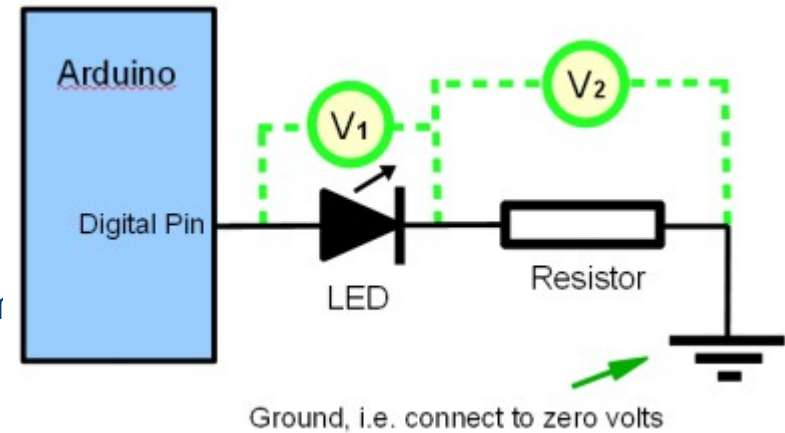



Variable - hvad er det

- Storage. Vi skal have en måde at gemme data på mens programmet kører
- Program = kode + data !!!
- Variable skal erklæres **FØR** man bruger som (i modsætning til python)
- Du skal angive **hvilken type** variabel det er (i modsætning til python)
- Der er ret **streng typecheck** så kan ikke blander æbler og pærer (i mod...)



variabeltype no 1 - heltal

- heltal - talletal: 1 2 3 4 654 6875 0 -123 -444 -23

Erklæring:

```
<typenavn> <variabelNavn>;
```

...

(std man skriver < > når man forklarer)

```
int etHeltal;
```

```
int et andet helTal, kurt;
```

```
1 int helTal; ←
2
3 void setup()
4 {
5     helTal = 33; ←
6     Serial.begin(115200);
7     delay(1000);
8 }
9
10
11 void loop() {
12
13     Serial.print("tal er ");
14     Serial.println(helTal);
15
16     helTal = helTal + 1; ←
17     // udregn til højre for lighedstegn
18     // gem i venstre side
19     delay(500);
20 }
```



Variable II

- simpel matematik til rådighed

```
int a,b,c,d,res;
```

```
res = (a+b) / (c + d);
```

eller

```
res = res * ((a+b) / (c + d));
```

kan også skrives som

```
res *= ((a+b) / (c + d));
```

BRUG RIGELIGT MED PARANTESER

SLØVER IKKE DIN KODE NED !

```
1 int helTal;
2
3 int andetTal, hest;
4
5 void setup()
6 {
7     helTal = 33;
8     hest = helTal + 4;
9     andetTal = hest + 4*helTal;    // + - * /
10    Serial.begin(115200);
11    delay(1000);
12 }
13
14
15 void loop() {
16
17     Serial.print("tal er ");
18     Serial.println(helTal);
19
20     helTal = helTal + 1;
21     // udregn til højre for lighedstegn
22     // gem i venstre side
23     delay(500);
24 }
```



paranteser

- De to følgende er ens da der er rækkefølge i udførelse af regneoperationer.
- kaldes på engelsk operator precedence
 - https://www.tutorialspoint.com/cprogramming/c_operators_precedence.htm
- * og / udføres FØR + -
- Sidste operator der udføres er =



| Category | Operator | Associativity |
|----------------|-------------------------------------|---------------|
| Postfix | () [] -> . ++ -- | Left to right |
| Unary | + - ! ~ ++ -- (type)* & sizeof | Right to left |
| Multiplicative | * / % ← | Left to right |
| Additive | + - ← | Left to right |
| Shift | << >> | Left to right |
| Relational | < <= > >= | Left to right |
| Equality | == != | Left to right |
| Bitwise AND | & | Left to right |
| Bitwise XOR | ^ | Left to right |
| Bitwise OR | | Left to right |
| Logical AND | && | Left to right |
| Logical OR | | Left to right |
| Conditional | ?: | Right to left |
| Assignment | = += -= *= /= %= >>= <<= &= ^= = ← | Right to left |
| Comma | , | Left to right |



heltal - er der mere ???

- Et heltal har max positiv og max negativ værdier den kan holde
- Arduino
 - **int**: fylder 16 bit - dvs der er 2^{16} værdier = 65536 værdier
 - 32768 negative tal: -32768 til -1
 - 0 (tallet 0)
 - 32767 positive tal: 1 til 32767
 - ialt 65536 tal
- ESP32
 - **int**: fylder 32 bit dvs der er 2^{32} værdier = 4294967296 værdier (ca 4 mia)
 - -2147483648 negative tal: -2147483648 til -1
 - 0 (tallet 0)
 - 2147483647 positive tal: 1 til 2147483647
 - ialt 4294967296 tal
- 64 bit
 - $2^{64} \approx 1,8 \cdot 10^{19}$ eller ca $\pm 9 \cdot 10^{18}$
 - puhaa mange tal
- *Jordens befolkning er lige nu ca 7800000000 (7,8 mia)*
- *Så den kan repræsenteres vha int 16 ? eller 32 ? eller 64 ?*



kommatal - float

- Man kan regne med kommatal med + - * /

```
float etKommaTal;
```

```
etKommaTal = 1.24;
```

```
// NB "." som decimaloperator
```

```
etKommaTal = 2* 3.4;
```

```
etKommaTal = - 1.4e17;
```

- Er 32 bit float ikke nok
- er der 64 bit double

```
1  
2  
3 float kommaTal;  
4  
5 void setup()  
6 {  
7   Serial.begin(115200);  
8   delay(1000);  
9 }  
0  
1  
2 void loop() {  
3  
4   Serial.print("sizeof float ");  
5   Serial.println(sizeof(float));  
6  
7   Serial.print("sizeof double");  
8   Serial.println(sizeof(double));  
9  
0  
1   delay(2000);  
2 }
```

```
sizeof float 4  
sizeof double8  
sizeof float 4  
sizeof double8
```

Autoscroll Show timestamp



enkle typer

| Type & Description |
|---|
| char Typically a single octet(one byte). It is an integer type. |
| int The most natural size of integer for the machine. |
| float A single-precision floating point value. |
| double A double-precision floating point value. |
| void Represents the absence of type. |



Analog input

- Kan måle spændinger 0-5V som udgangspunkt
- 10 bit ADC (analogtilDigitalConverter) dvs $2^{10} = 1024$ niveaue
- 0 -> 5.0V ==> 0 -> 1023

```
void setup()
{
  Serial.begin(9600);
}

void loop()
{
  int i;
  float voltage;
  i = analogRead(A0); (UNO A0,A1,... A5 - du kan også bare skrive 0,1,...)

  voltage = 5.0*i/1023;

  Serial.println(voltage);

  delay(100); // sov 100 millisekunder
}
```



rdy - go

- åben serial terminal
- luk serial terminal
- åben serial plotter



BREAK



Digital input/output

- Se arduino comic
-



BMP085 / BMP180

- Trykmåler
- +- 30cm nøjagtige
 - (omregnet til luftryk/højde)
- I2C interface s

```
1 #include <Wire.h>
2 #include <bmp085.h>
3
4 /*
5 1. call bmp085_init
6   - parameter pressure at sealevel (in Pascal) or 0
7   if 0 then 101325 (std pressure at sea level) is used
8
9 2. Measurement by
10  a. call bmp085_measure()
11  b. now pressure and temperature is in float variables bmp085_temp and br
12 */
13 |
14
15 void setup()
16 {
17   Serial.begin(9600);
18   Wire.begin();
19
20   bmp085Init(101300.0); // ress at sealevel today
21 }
22
23 float temp, atm, alt, pres;
24
25
26 #define LOOPTIME 200
27 unsigned long t1, t3;
28
29 void loop()
30 {
31   float tryk, temp, hojde;
32   bmp085Measure(&temp, &tryk, &hojde);
33
34   Serial.print("temp(C) "); Serial.print(temp);
35   Serial.print("\t tryk(Pa) "); Serial.print(tryk);
36   Serial.print("\t hojde(m)"); Serial.println(hojde);
37   delay(100);
38 }
```



```
1 #include <Wire.h>
2 #include <bmp085.h>
3
14
15 void setup()
16 {
17     Serial.begin(9600);
18     Wire.begin();
19
20     bmp085Init(101300.0); // res at sealevel today
21 }
22
23 float temp, atm, alt, pres;
24
25 void loop()
26 {
27     float tryk, temp, hojde;
28     bmp085Measure(&temp, &tryk, &hojde);
29
30     Serial.print("temp(C) "); Serial.print(temp);
31     Serial.print("\t tryk(Pa) "); Serial.print(tryk);
32     Serial.print("\t hojde(m)"); Serial.println(hojde);
33     delay(100);
34 }
```



så var der lige Openlogger

- Logger alt hvad der bliver skrevet hvis
 - openlog er konfigureret til rette hastighed (med tomt sd-kort kører den 9600)
 - Jumper J4 er sat på

- hvad er dagens lufttryk i Bjerringbro ?
- Ret i koden i bmp08test
- compiler og upload kode
- Sæt jumper på J4
- Sæt SDcard i Openlogger
- Sæt batteri til

- gå en tur ned ad trappen og op igen
- fjern batteri

- Hvad er der på sd kort ?



MPU6050

- 3 akser acceleration og gyro
- I2C interface
-
-

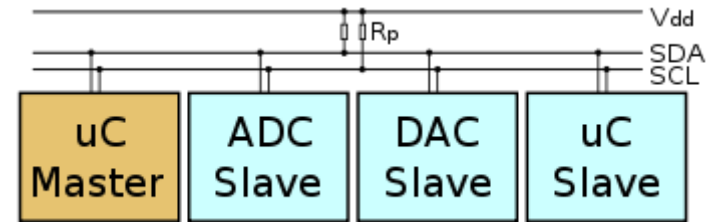



- example: accgyrotes in MPU6050
- to code

```
3
4 #include "MPU6050.h"
5 #include "Wire.h"
6 MPU6050 accelgyro(0x68);
7
8 int16_t gx, gy, gz;
9 int16_t ax, ay, az;
10
11 #define LED_PIN 13
12 bool blinkState = false;
13
14 void setup() {
15   Serial.begin(38400); // start serial port
16
17   Wire.begin(); // start i2c bnetwork
18
19   accelgyro.initialize(); // initalize mpu6050
20
21   if (accelgyro.testConnection()) {
22     Serial.println("MPU6050 ok ");
23   }
24   else {
25     Serial.println("MPU6050 fail ");
26     while (1); // stop here
27   }
28
29   pinMode(LED_PIN, OUTPUT);
30 }
31
32 void loop() {
33
34   // read raw accel/gyro measurements from device
35   accelgyro.getMotion6(&ax, &ay, &az, &gx, &gy, &gz);
36   Serial.print("a/g:\t");
37   Serial.print(ax); Serial.print("\t");
38   Serial.print(ay); Serial.print("\t");
39   Serial.print(az); Serial.print("\t");
40   Serial.print(gx); Serial.print("\t");
41   Serial.print(gy); Serial.print("\t");
42   Serial.println(gz);
43
44   // blink LED to indicate activity
45   blinkState = !blinkState;
46   digitalWrite(LED_PIN, blinkState);
47 }
48
```



HMC5983

- 3 akses magnetometer
- Husk feltet over Danmark peger ned med en vinkel på ca 60 grader

```
#include <HMC5983.h>
#include <Wire.h>
```

```
HMC5983 compass;
```

```
void setup () {
  Serial.begin(9600);
  Serial.println(" heading / x y z composanter");
  delay(3000);
  compass.begin(); // use "true" if you need some debug information
}
```

```
void loop() {
  float x, y, z;
  float c = -999;
  c = compass.readAll(&x, &y, &z);
  if (c == -999) {
    Serial.print("Reading error, discarded");
    return;
  } else {
    Serial.print(c);
  }
  Serial.print(" ");
  Serial.print(x); Serial.print(" ");
  Serial.print(y); Serial.print(" ");
  Serial.println(z);
}
```



HMC5983

- output x,y,z -2048 - 2047
- et count == 0.92 mG
- range default is +- 1.3 Gauss

- earth magn field 0.25 - 0.65 Gauss



BREAK



RADIO - APC220

- transmitterer alt hvad der skrives mpå serielle port
- kan også modtage kommunikation den anden vej

- J2 hvsi du vil sende data hjem
- J3 hvis du vil modtage data hjemmefra

- kommunikations til Arduino 1200 og op til 57600 baud
- kommunikation i luften 2400 og op til 19200
 - højere hastighed i luften == kortere rækkevidde

- ANBEFALING

- I luft max 9600 - gerne 4800 hvis databudget er til det
- Internt max 19200

- Frekvenser 433,05 MHz – 434,79 MHz (center 433,92 MHz) (stærkt benyttet)

- Radio kan 418-455 MHz - beware !!!

- Kan/er (lidt) anderledes i udlandet.



endelig

- velkommen
- udlevering af kit
 - install af SW
 - arduino IDE
- gennemgang af cansat shield
 - biblioteker for cansat shield
- Afdækning af folks programmeringserfaringer
 - gætter på fra ingenting til meget kompetente
- enkle hello world programmer

- start på kit
- trykmåler (bmp085/bmp180/...)
- accelerometer (MPU6050)
- gyro (MPU6050)
- magnetometer (hmc5983)
- logning på sd card
- radiolink
- **apc220**
- **configuration**
- **den store test**
- **pewwww**